

Datasheet



- Intrinsically safe sensors with MINI-BEAM performance and small size
- For use with approved switching amplifiers with intrinsically safe input circuits
- Output 1 mA or less in the dark and 2 mA or more in the light
- Models with integral cable or quick-disconnect



WARNING: Not To Be Used for Personnel Protection

Never use this device as a sensing device for personnel protection. Doing so could lead to serious injury or death. This device does not include the self-checking redundant circuitry necessary to allow its use in personnel safety applications. A sensor failure or malfunction can cause either an energized or de-energized sensor output condition.

Models

Model ¹	Sensing Mode	Sensing Beam	Sensing Range	Output Type
MI 9E Emitter	Opposed	Infrared, 880 nm	Range: 6 m (20 ft)	Constant Current ≤ 1.2 mA dark ≥ 2.1 mA light
MIAD9R Receiver				
MIAD9LVAG	Polarized Retroreflective	Visible red, 650 nm	50 mm to 2 m (2 in to 7 ft)	
MIAD9LV	Retroreflective	Visible red, 650 nm	5 m (16.4 ft)	
MIAD9D	Diffuse	Infrared, 880 nm	380 mm (15 in)	
MIAD9W	Divergent Diffuse	Infrared, 880 nm	75 mm (3 in)	
MIAD9CV	Convergent	Visible red, 650 nm	16 mm (0.6 in)	
MIAD9CV2			43 mm (1.7 in)	
Fiber Optic (Glass)	MIAD9F	Infrared, 880 nm	Range varies by sensing mode and fiber optics used	

¹ Only standard 2 m (6.5' ft) cable models are listed. For 4-pin Euro-style Integral QD models: add suffix "Q" to the model number (for example, MIAD9RQ); accessory mating cable required.



Overview

MIAD9 Series NAMUR Sensors are small, rugged, self-contained two-wire sensors designed for use with approved switching amplifiers with intrinsically safe input circuits. MIAD9 Series sensors are designed in accordance with DIN 19 234.

These sensors vary the impedance across the sensor output, which passes 1 mA or less in the “dark” condition and 2 mA or more in the “light” condition. A red LED on the rear of the sensor lights whenever the sensor sees the “light” condition. A rugged, clutched, 15-turn slotted brass screw Gain control potentiometer enables precise adjustment of system sensitivity.

Models are available with either a 2 m (6.5 ft) or 10 m (30 ft) long attached PVC-covered cable, or a 4-pin Euro-style quick disconnect (QD) connector. Quick disconnect models (with “Q” in the model number suffix) use MQD9-4.. mating cable (either straight or right angle connector; see [Quick-Disconnect \(QD\) Cables](#) on page 8). Contact Banner Engineering for availability of sensor models with 10 m (30 ft) long attached cable.



NOTE: If sensors with output characteristics according to DIN 19 234 are used in hazardous areas, they must be used with approved switching amplifiers with intrinsically safe input circuits.

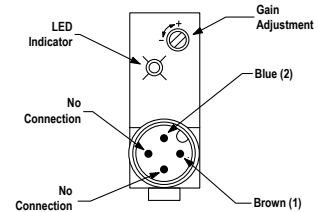

Figure 1. Features (rear of sensor, quick-disconnect model shown)

Special Conditions for Safe Use. Parts of the enclosure are non-conducting and may generate an ignition-capable level of ESD. Cleaning of the equipment shall be done only with a damp cloth.

Hazardous Area Application. Associated apparatus may include amplifiers and barriers to monitor apparatus supply current, which is the apparatus output signal. Associated apparatus must limit both supply voltage and supply current in the event of failures.

Installation Notes

Hazardous Area Application

Entity Parameters: Associated Apparatus may include amplifiers and barriers to monitor apparatus supply current, which is the apparatus output signal. Associated apparatus must limit both supply voltage and supply current in the event of failures.



CAUTION: Electrostatic Discharge (ESD)

Special Conditions for Safe Use. Parts of the enclosure are non-conducting and may generate an ignition-capable level of ESD. Cleaning of the equipment shall be done only with a damp cloth.

Associated Apparatus		Sensor Apparatus	
$V_{oc} \leq 15V \text{ dc}$	Cable Parameters (if unknown)	$V_{max} = 15V \text{ dc}$	$L_i = 0$
$I_{sc} \leq 60 \text{ mA}$	$C(\text{cable}) = 60 \text{ pF/ft.}$	$I_{max} = 60 \text{ mA}$	$P_i = 225 \text{ mW}$
$C_a \geq C(\text{cable}) + C_i$	$L(\text{cable}) = 0.2 \text{ } \mu\text{H/ft.}$	$C_i = 0.3 \text{ } \mu\text{F}$	
$L_a \geq L(\text{cable}) + L_i$			

FM Installation

- Associated Apparatus (barrier) entity parameters must meet the following requirements:
 - $V_{oc} \leq V_{max}$
 - $I_{sc} \leq I_{max}$
 - $C_a \geq C_i + C_{cable}$
 - $L_a \geq L_i + L_{cable}$
- The Associated Apparatus shall not be connected to any device that uses or generates in excess of 250 Volts rms or dc.
- Intrinsic safety ground, if required for the Associated Apparatus, shall be less than 1 ohm.
- Installation shall be in accordance with the National Electrical Code (ANSI/NFPA70), local codes, Associated Apparatus manufacturer’s installation requirements and ANSI/ISA RP12.6 for hazardous (classified) location installation.

5. Associated Apparatus is not required for installation of the devices within a Division 2 hazardous (classified) location. The maximum voltage for Division 2 installation is 15V dc.
6. Maximum connector torque: 6 ft-lbs.

CSA Installation

1. Associated Apparatus (barrier) entity parameters must meet the following requirements:
 - $V_{oc} \leq V_{max}$
 - $I_{sc} \leq I_{max}$
 - $C_a \geq C_i + C_{cable}$
 - $L_a \geq L_i + L_{cable}$
2. The Associated Apparatus shall not be connected to any device that uses or generates in excess of 250 Volts rms or dc.
3. Intrinsic safety ground, if required for the Associated Apparatus, shall be less than 1 ohm.
4. Installation shall be in accordance with the Canadian Electrical Code, Part 1.
5. Associated Apparatus (barrier) shall be installed in accordance with the manufacturer's instructions.
6. Associated Apparatus is not required for installation of the devices within a Division 2 hazardous (classified) location when installed in, or through the wall of a suitable enclosure with provision for connection of rigid metal conduit per the Canadian Electrical Code, as acceptable to the local inspection authority having jurisdiction. The maximum rating for Division 2 installation is 15V dc, 60 mA.
7. In Division 2 installations, observe the following warning.



WARNING: Explosion Hazard

Do not disconnect equipment unless power has been switched Off or the area is known to be non-hazardous.

Specifications

Supply Voltage and Current

5 to 15 V dc (provided by the amplifier to which the sensor is connected)

Adjustments

15-turn slotted brass screw GAIN (sensitivity) adjustment potentiometer (clutched at both ends of travel); located on rear panel and protected by a clear gasketed acrylic cover

Indicators

Red LED Alignment Indicator Device (AID) located on rear panel lights when the sensor sees a "light" condition; pulse rate is proportional to signal strength (the stronger the signal, the faster the pulse rate).

Construction

Reinforced thermoplastic polyester housing, totally encapsulated, o-ring sealing, acrylic lenses, and stainless steel screws

Output

Constant current output: ≤ 1.2 mA in the "dark" condition and ≥ 2.1 mA in the "light" condition

Output Response Time

Opposed mode: 2 ms ON/400 μ s OFF

All other modes: 5 ms ON/OFF (does not include amplifier response)

Environmental Rating

Banner tested to NEMA standards 1, 2, 3, 3S, 4, 4X, 6, 12 and 13
IEC IP67

Operating Conditions

Temperature: -40 °C to $+70$ °C (-40 °F to $+158$ °F)

Connections

PVC-jacketed 2-conductor 2 m or 9 m cables, or special 4-pin Euro-style quick-disconnect (QD) fitting are available; QD cables are ordered separately.

Design Standards

ATEX (European)	EN 60079-0, EN 60079-11, and EN 60079-26
Canada	CAN/CSA C22.2, No. 142-M1987, No.157-92, No. 1010.1, E60079-0, and E60079-11
United States	FM Class 3600, 3610, and 3810, ANSI/ISA 61010-1 (82.02.01), ANSI/ISA 60079-0, 60079-11, and 60079-26
IECEX	IEC 60079-0, IEC 60079-11

Certifications



130848D

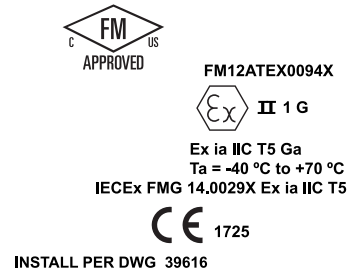

Approvals

<p>ATEX (European)</p>	<p>II 1 G Ex ia IIC T5 Ga Ta = -40 °C to 70 °C - 39616; Entity: FM12ATEX0094X Entity Parameters: V_{Max} = 15 V dc, I_{Max} = 60 mA, C_i = 0.3 µF, L_i = 0 mH.</p>
<p>Canada</p>	<p>Intrinsically safe for Class I, II and III, Division 1, Groups A, B, C, D, E, F and G T5 Ta = -40 °C to 70 °C - 39616; Entity Non-incendive for Class I, Division 2, Groups A, B, C and D, T5 Ta = -40 °C to 70 °C Intrinsically safe for Class I, Zone 0 Ex ia Group IIC T5 Ta = -40°C to 70°C - 39616; Entity Entity Parameters: V_{Max} = 15 V dc, I_{Max} = 60 mA, C_i = 0.3 µF, L_i = 0 mH. a = Sensing mode D, W, F, LV, LVAG, CV, CV2 or R. b = Connection method Q or blank.</p>
<p>United States</p>	<p>Intrinsically safe for Class I, II and III, Division 1, Groups A, B, C, D, E, F and G T5 Ta = -40 °C to 70 °C - 39616; Entity Non-incendive for Class I, Division 2, Groups A, B, C and D, T5 Ta = -40 °C to 70 °C Suitable for Class II and III, Division 2 (Class II and III, Division 2 applies only to model numbers ending in suffix "Q"), Groups F and G*, T5 Ta = -40 °C to 70 °C Intrinsically safe for Class I, Zone 0 AEx ia Group IIC T5 Ga Ta = -40 °C to 70 °C; Entity Entity Parameters: V_{Max} = 15 V dc, I_{Max} = 60 mA, C_i = 0.3 µF, L_i = 0 mH. a = Sensing mode D, W, F, LV, LVAG, CV, CV2 or R. b = Connection method Q or blank.</p>
<p>IECEX</p>	<p>Ex ia IIC T5 Ta= -40 °C to +70 °C - 39616; Entity IECEx FMG 14.0029X Entity Parameters: V_{max}= 15 V dc, I_{max}= 60 mA, C_i=0.3 µf, L_i=0 mH</p>

Performance Curves

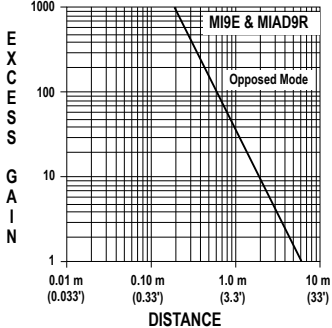
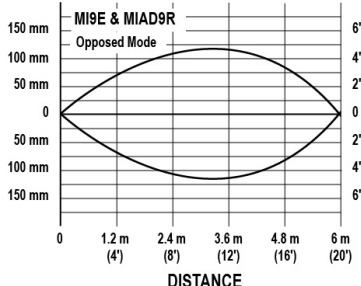
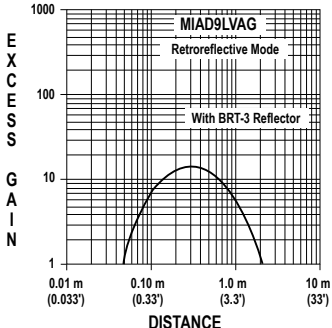
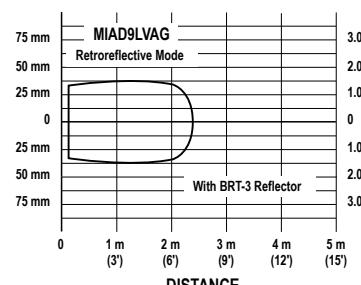
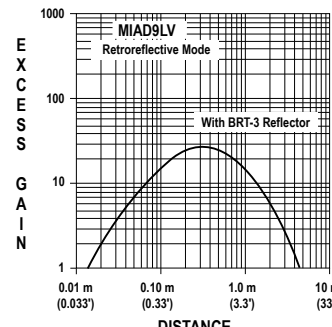
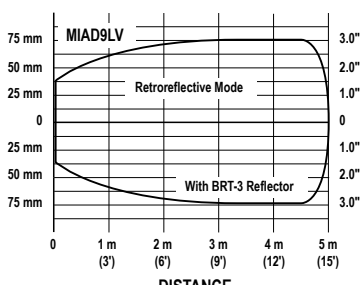
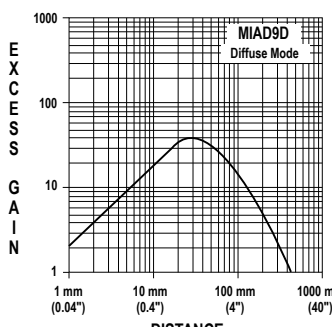
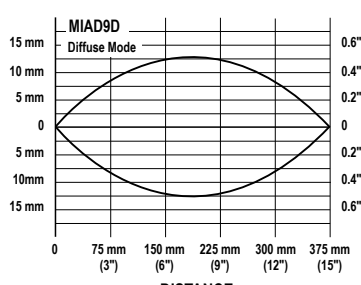
Model	Excess Gain	Beam Pattern
Diffuse mode performance based on 90% reflectance white test card		
MI 9E Emitter MI AD9R Receiver		
MI AD9LVAG		
MI AD9LV		
MI AD9D		

Model	Excess Gain	Beam Pattern
Diffuse mode performance based on 90% reflectance white test card		
MIAD9W	<p>MIAD9W Divergent Mode Diffuse Mode</p>	<p>MIAD9W Divergent Mode</p>
MIAD9CV	<p>MIAD9CV Convergent Mode</p>	<p>MIAD9CV Convergent Mode</p>
MIAD9CV2	<p>MIAD9CV2 Convergent Mode</p>	<p>MIAD9CV2 Convergent Mode</p>
MIAD9F—Opposed Mode	<p>MIAD9F Opposed Mode Glass Fibers IT13S Fiber IT23S Fiber</p>	<p>MIAD9F Opposed Mode IT13S IT23S</p>

Model	Excess Gain	Beam Pattern
	Diffuse mode performance based on 90% reflectance white test card	
MI AD9F—Diffuse Mode		

Dimensions

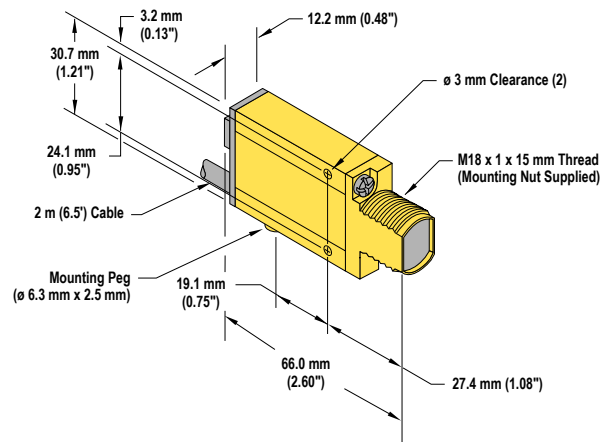

Figure 2. Opposed, Retro, Diffuse, Convergent Models (Suffix E, R, LV, D, and CV)

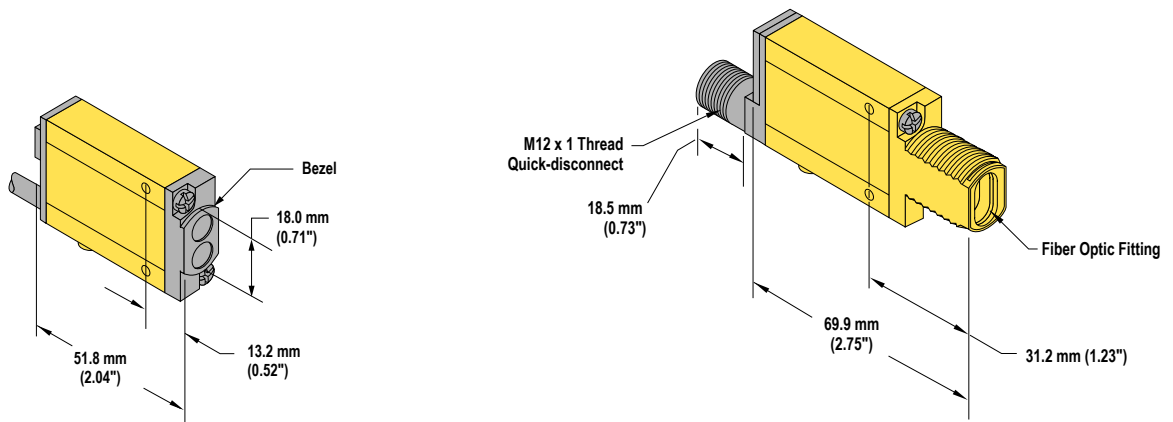
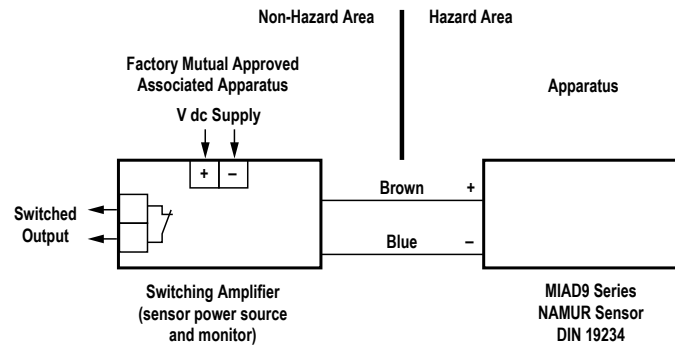

Figure 3. Diffuse Models (suffix W)

Figure 4. Glass Fiber Models (suffix F)

Hookups



Accessories

Quick-Disconnect (QD) Cables

4-Pin Threaded M12/Euro-Style Cordsets (for use with NAMUR sensors)				
Model	Length	Style	Dimensions	Pinout (Female)
MQD9-406	1.83 m (6 ft)	Straight		<p>1 = Brown 2 = Blue</p>
MQD9-415	4.57 m (15 ft)			
MQD9-430	9.14 m (30 ft)			
MQD9-406RA	1.83 m (6 ft)	Right-Angle		
MQD9-415RA	4.57 m (15 ft)			
MQD9-430RA	9.14 m (30 ft)			

Brackets

SMB312S

- Stainless steel 2-axis, side-mount bracket

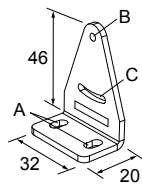

A = 4.3 × 7.5, B = diam. 3, C = 3 × 15.3

SMB46U

- Right-angle
- U bracket for sensor protection
- 14-ga. 316 stainless steel

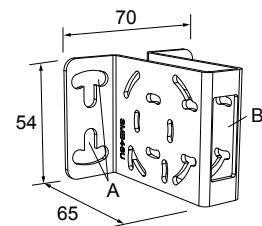

Hole center spacing: A = 16.0

Hole size: A = 16.5 × 18.7, B = 34.0 × 13.0

SMB312B

- Stainless steel 2-axis, bottom-mount bracket
- Includes mounting foot

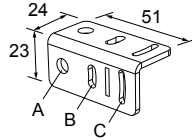

A = diam. 6.9, B = 4.3 × 10.5, C = 3.1 × 15.2

SMB18A

- Right-angle mounting bracket with a curved slot for versatile orientation
- 12-ga. stainless steel
- 18 mm sensor mounting hole
- Clearance for M4 (#8) hardware

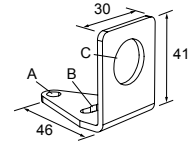

Hole center spacing: A to B = 24.2
Hole size: A = ø 4.6, B = 17.0 × 4.6, C = ø 18.5

SMB312PD

- Right-angle mounting bracket with a curved slot for versatile orientation
- 12-ga. stainless steel
- 18 mm sensor mounting hole
- Clearance for M4 (#8) hardware

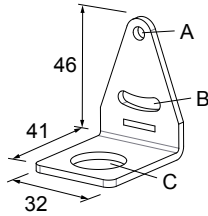

Hole center spacing: A to B = 24.2
Hole size: A = ø 4.6, B = 17 × 4.6, C = ø 18.5



NOTE: Not for use with plastic fiber optic sensors

SMB18FA..

- Swivel bracket with tilt and pan movement for precision adjustment
- Easy sensor mounting to extruded rail T-slots
- Metric and inch size bolts available
- 18 mm sensor mounting hole

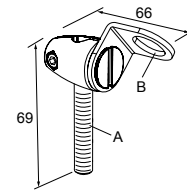

Hole size: B = ø 18.1

Model	Bolt Thread (A)
SMB18FA	3/8 - 16 × 2 in
SMB18FAM10	M10 - 1.5 × 50
SMB18FA12	n/a; no bolt included. Mounts directly to 12 mm (½ in) rods

SMB46L

- Right-angle
- L bracket
- 14-ga. 316 stainless steel

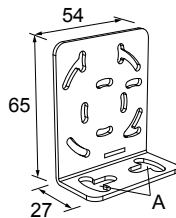

Hole center spacing: A = 16.0

Hole size: A = 16.5 × 18.7

SMB18Q

- Right-angle flanged bracket
- 18 mm sensor mounting hole
- 12-ga. stainless steel

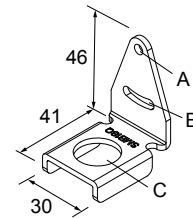

Hole center spacing: A to B = 24.2
Hole size: A = ø 4.6, B = 17.0 × 4.6, C = ø 19.0

SMB46S

- Right-angle
- S bracket
- 14-ga. 316 stainless steel

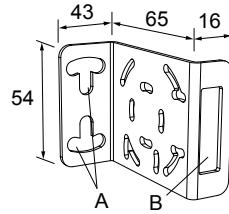

Hole center spacing: A = 16.0

Hole size: A = 16.5 × 18.7, B = 34.0 × 10.0

SMB18SF

- 18 mm swivel bracket with M18 × 1 internal thread
- Black thermoplastic polyester
- Stainless steel swivel locking hardware included

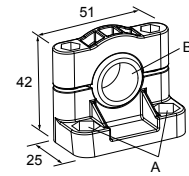

Hole center spacing: A = 36.0
Hole size: A = ø 5.3, B = ø 18.0

SMB3018SC

- 18 mm swivel side or barrel-mount bracket
- Black reinforced thermoplastic polyester
- Stainless steel swivel locking hardware included

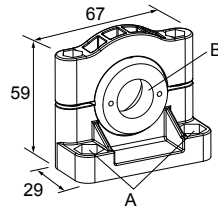

Hole center spacing: A = 50.8

Hole size: A = ø 7.0, B = ø 18.0

SMB18UR

- 2-piece universal swivel bracket
- 300 series stainless steel
- Stainless steel swivel locking hardware included
- Mounting hole for 18 mm sensor

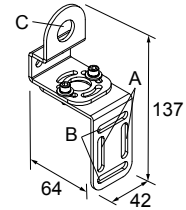

Hole center spacing: A = 25.4, B = 46.7

Hole size: B = 6.9 × 32.0, C = ø 18.3

SMB30SUS

- Side-mount swivel with extended range of motion
- Black reinforced thermoplastic polyester
- Stainless steel swivel locking hardware included

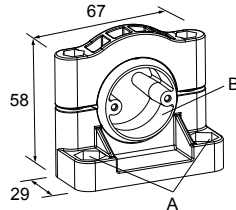

Hole center spacing: A = 50.8, B = 24.1

Hole size: A = ø 7, B = ø 7.6

SMBAMS18P

- Flat SMBAMS series bracket with 18 mm hole
- Articulation slots for 90+ ° rotation
- 12-ga. (2.6 mm) cold-rolled steel

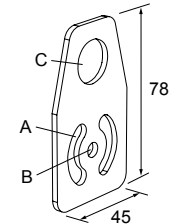

Hole center spacing: A = 26.0, A to B = 13.0

Hole size: A = 26.8 × 7.0, B = ø 6.5, C = ø 19.0

SMB30SK

- Flat-mount swivel bracket with extended range of motion
- Black reinforced thermoplastic polyester and 316 stainless steel
- Stainless steel swivel locking hardware included

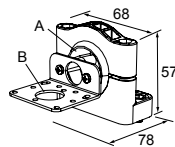

Hole center spacing: A = 50.8

Hole size: A = ø 7, B = ø 18

SMBAMS18RA

- Right-angle SMBAMS series bracket with 18 mm hole
- Articulation slots for 90+ ° rotation
- 12-ga. (2.6 mm) cold-rolled steel

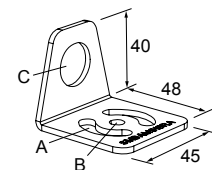

Hole center spacing: A = 26.0, A to B = 13.0

Hole size: A = 26.8 × 7.0, B = ø 6.5, C = ø 19.0

Repairs and Translations

Obtain assistance with product repairs by contacting your local Banner Engineering Corp distributor or by calling Banner directly at (763) 544-3164. Access literature translated into your native language on the Banner website at www.bannerengineering.com or contact Banner directly at (763) 544-3164.

Banner Engineering Corp Limited Warranty

Banner Engineering Corp. warrants its products to be free from defects in material and workmanship for one year following the date of shipment. Banner Engineering Corp. will repair or replace, free of charge, any product of its manufacture which, at the time it is returned to the factory, is found to have been defective during the warranty period. This warranty does not cover damage or liability for misuse, abuse, or the improper application or installation of the Banner product.

THIS LIMITED WARRANTY IS EXCLUSIVE AND IN LIEU OF ALL OTHER WARRANTIES WHETHER EXPRESS OR IMPLIED (INCLUDING, WITHOUT LIMITATION, ANY WARRANTY OF MERCHANTABILITY OR FITNESS FOR A PARTICULAR PURPOSE), AND WHETHER ARISING UNDER COURSE OF PERFORMANCE, COURSE OF DEALING OR TRADE USAGE.

This Warranty is exclusive and limited to repair or, at the discretion of Banner Engineering Corp., replacement. IN NO EVENT SHALL BANNER ENGINEERING CORP. BE LIABLE TO BUYER OR ANY OTHER PERSON OR ENTITY FOR ANY EXTRA COSTS, EXPENSES, LOSSES, LOSS OF PROFITS, OR ANY INCIDENTAL, CONSEQUENTIAL OR SPECIAL DAMAGES RESULTING FROM ANY PRODUCT DEFECT OR FROM THE USE OR INABILITY TO USE THE PRODUCT, WHETHER ARISING IN CONTRACT OR WARRANTY, STATUTE, TORT, STRICT LIABILITY, NEGLIGENCE, OR OTHERWISE.

Banner Engineering Corp. reserves the right to change, modify or improve the design of the product without assuming any obligations or liabilities relating to any product previously manufactured by Banner Engineering Corp.